

Garden Kerbs

We manufacture a range of kerbs for both garden and road use. These stylish kerbs come in different shapes to suit every taste and décor.

	Total Height	Bottom Width	Top Width	Base Height	Quantity per pallet
6" x 2" Round Top Kerb	150	50	43	-	120
6" x 2" Flat Top Kerb	150	50	43	-	120
6" x 3" Flat Top Kerb	150	75	70	-	84
9" x 2" Flat Top Kerb	225	52	50	-	40
6" x 3" Splayed Kerb	150	75	40	70	84
7" x 4" Splayed Kerb	175	100	55	80	40
<i>Kerbs are 915mm long</i>					

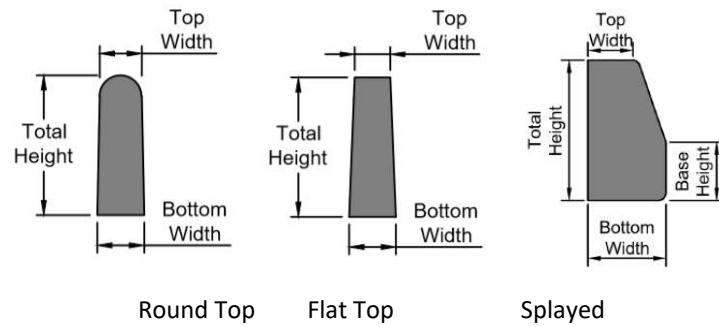

Garden Kerbs are not suitable for driving over with a vehicle.



6" x 2" Flat Top Kerbs



6" x 3" Flat Top Kerbs



6" x 2" Round Top Kerbs



6" x 3" Splayed Kerbs



7" x 4" Splayed Kerbs

9" x 2" Flat Top Kerbs can be used to cast an in-situ step or for domestic use.

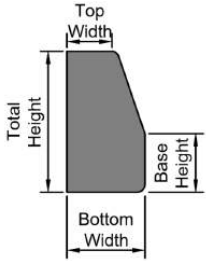

Half Batter Kerb

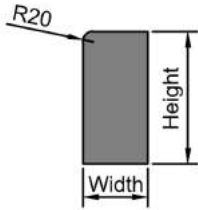

Bull Nose Kerb

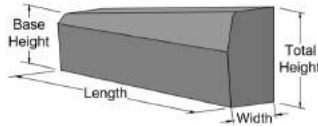

Right Hand Side Drop Kerb

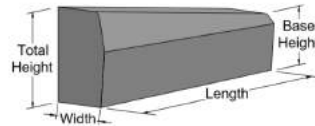

Left Hand Side Drop Kerb

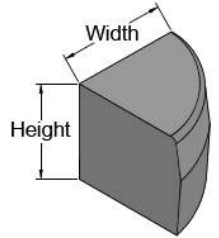

Quadrant Kerb

Half Batter Kerbs	Total Height	Bottom Width	Top Width	Base Height	Length	Quantity per pallet
6" x 5" Kerb	150	125	100	55	915	16
8" x 4" Kerb	200	100	85	100	915	20
10" x 5" Kerb	225	125	100	150	915	16
10" x 5" Thirds	225	125	100	150	305	48
10" x 5" Halves	255	125	100	150	450	32



8" x 4" Half Batter Kerb



6 x 5 Bull Nose Kerb



Left Hand Side Drop Kerb

Bull Nose Kerb	Height	Width	Quantity per pallet
10" x 5" Kerb	255	125	16
6" x 5" Kerb	150	125	16

Kerbs are 915mm long

	Total Height	Width	Base Height	Length
Drop Kerb	255	125	150	915
Quadrant (to suit 10" x 5")	255	125		



10" x 5" Half Batter Kerb



Quadrant



10" x 5" Half

Left Hand Side

6" x 5" Bull Nose Kerb

Right Hand Side Drop Kerb

10" x 5" Half Batter Kerb

Quadrant Kerb

DWARF WALLS

All dwarf walls are the same width to fit together for a seamless rise. They can retain a small amount of earth.

	Total Height	Bottom Width	Top Width	Base Height	Quantity per pallet
10"	255	80	25	160	32
15"	380	80	25	285	24
18"	450	80	25	355	16
24"	600	80	25	508	16
30"	760	90	30	640	16

Dwarf walls are 915mm long

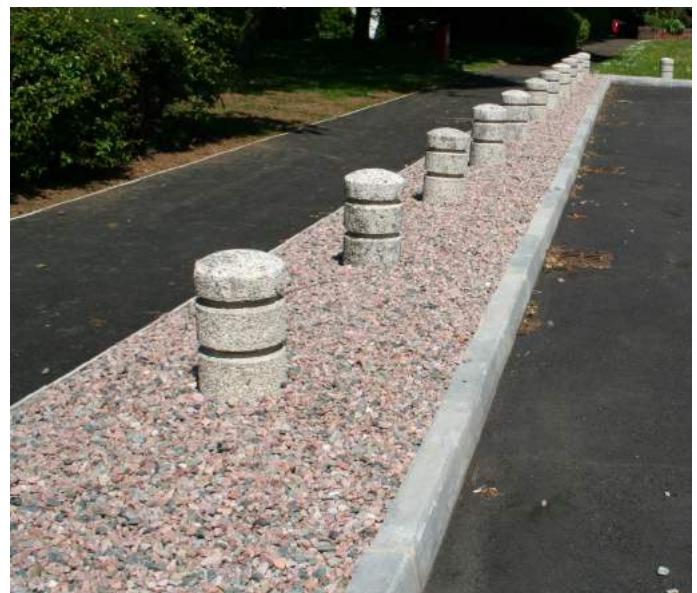
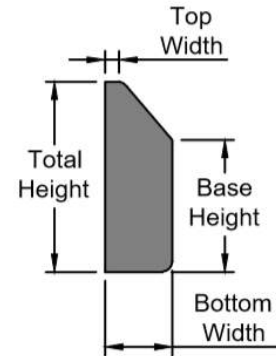

“Moores have a great team and excellent products. We’re very satisfied with the service.”

Alex Saul from Gibbs and Dandy, St Ives, Part of the Jewson Group.

Moore Concrete Products Ltd, Caherty House, 41 Woodside Road, Ballymena, County Antrim, Northern Ireland BT42 4QH

Tel: +44 (0) 28 2565 2566 Fax: +44 (0) 28 2565 8480

Web: www.moore-concrete.com Email: info@moore-concrete.com



INVESTOR IN PEOPLE

